

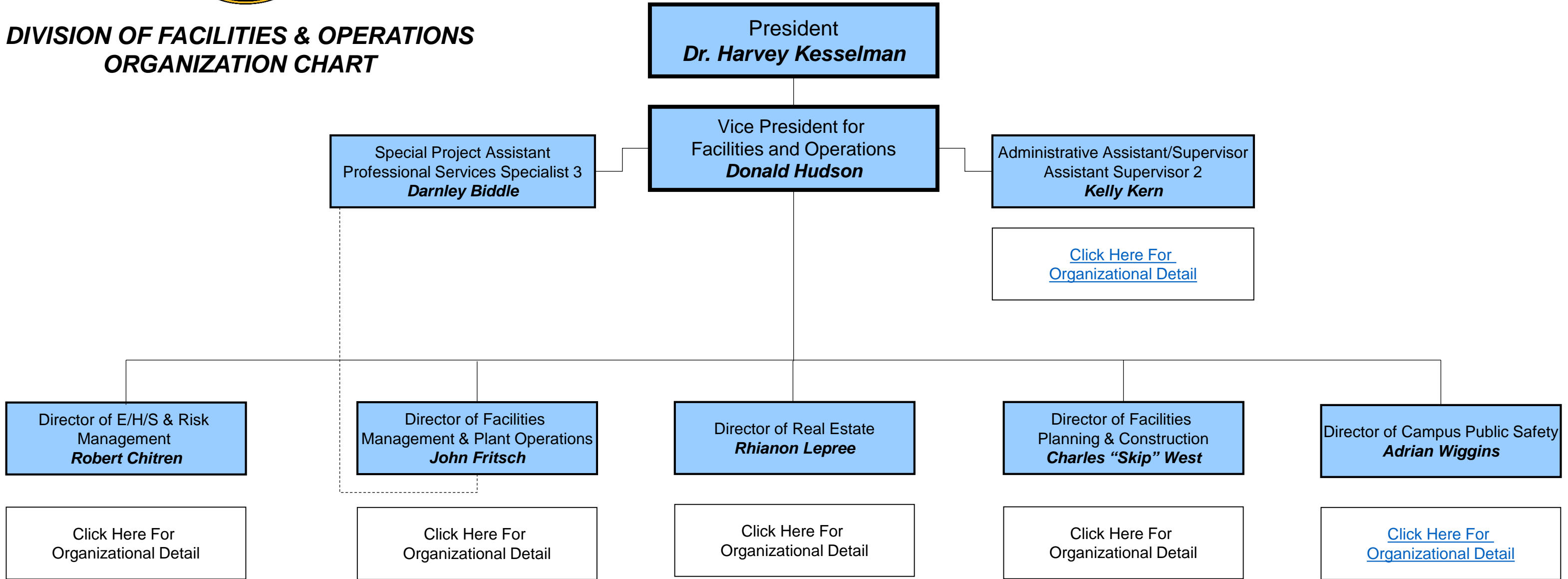

**DIVISION OF FACILITIES & OPERATIONS
ORGANIZATION CHART**





**OFFICE OF FACILITIES & CONSTRUCTION
OPERATIONS
ORGANIZATION CHART**

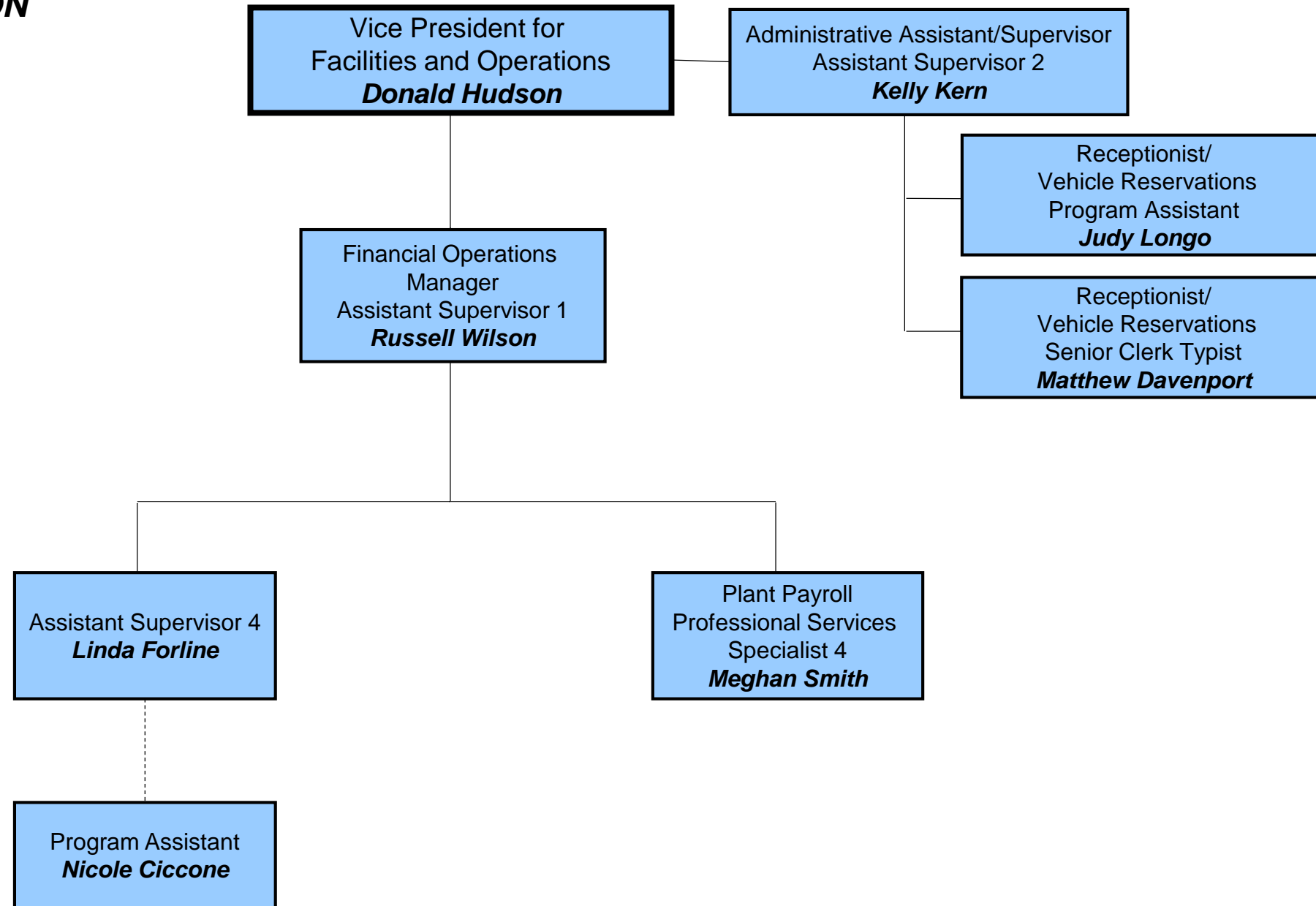



**OFFICE OF E/H/S & RISK MANAGEMENT
ORGANIZATION CHART**

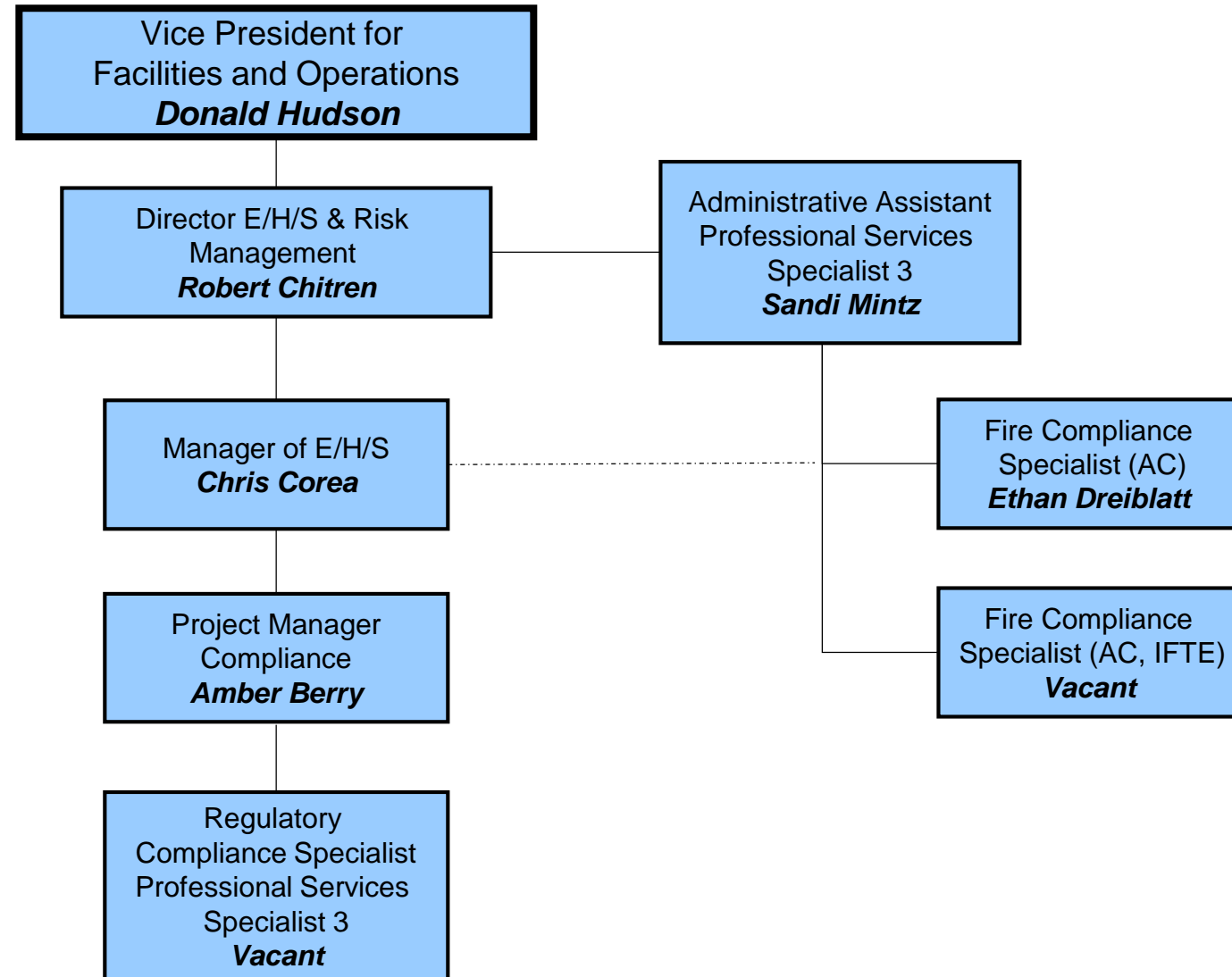



**OFFICE OF FACILITIES PLANNING &
CONSTRUCTION
ORGANIZATION CHART**

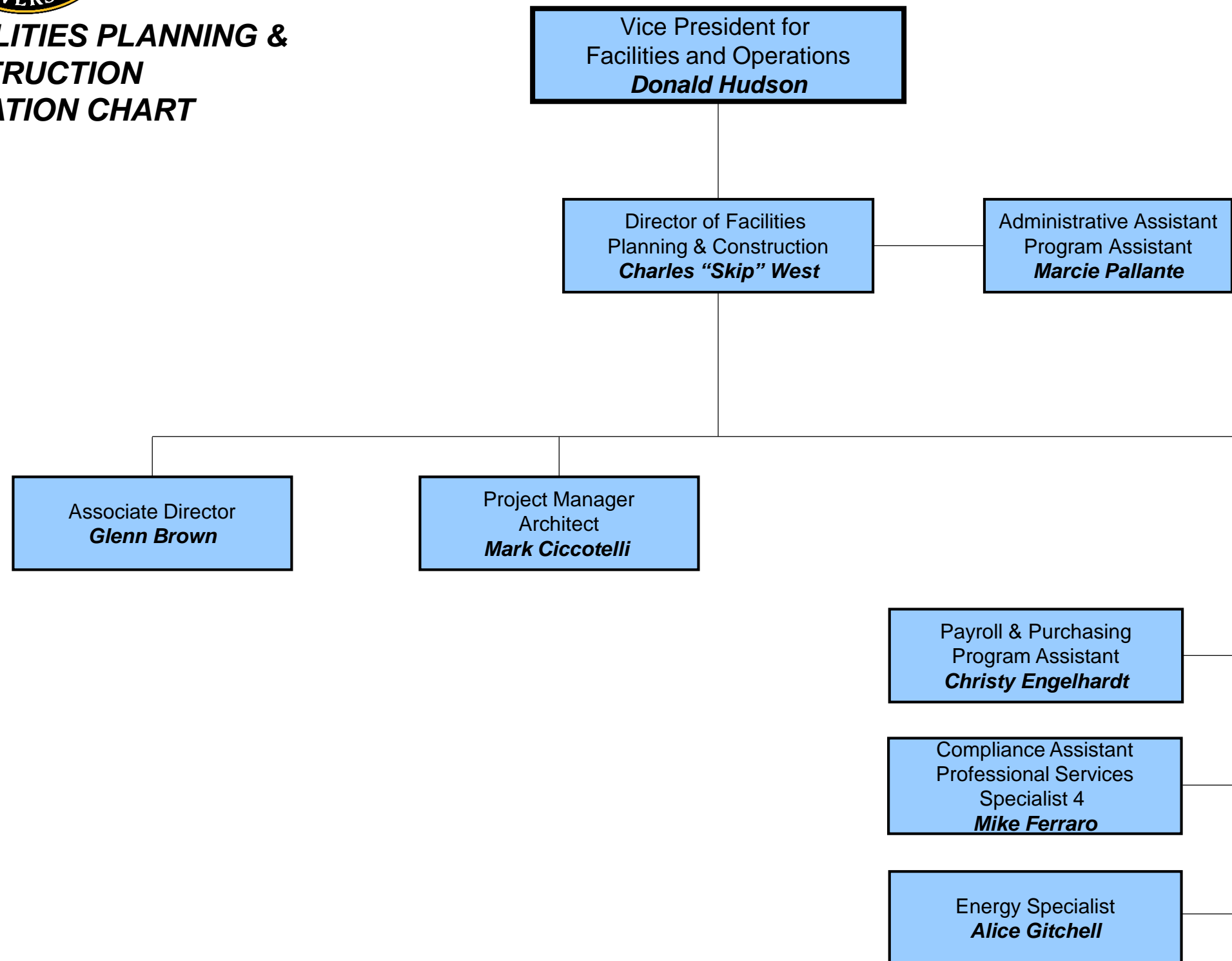



**OFFICE OF REAL ESTATE
ORGANIZATION CHART**

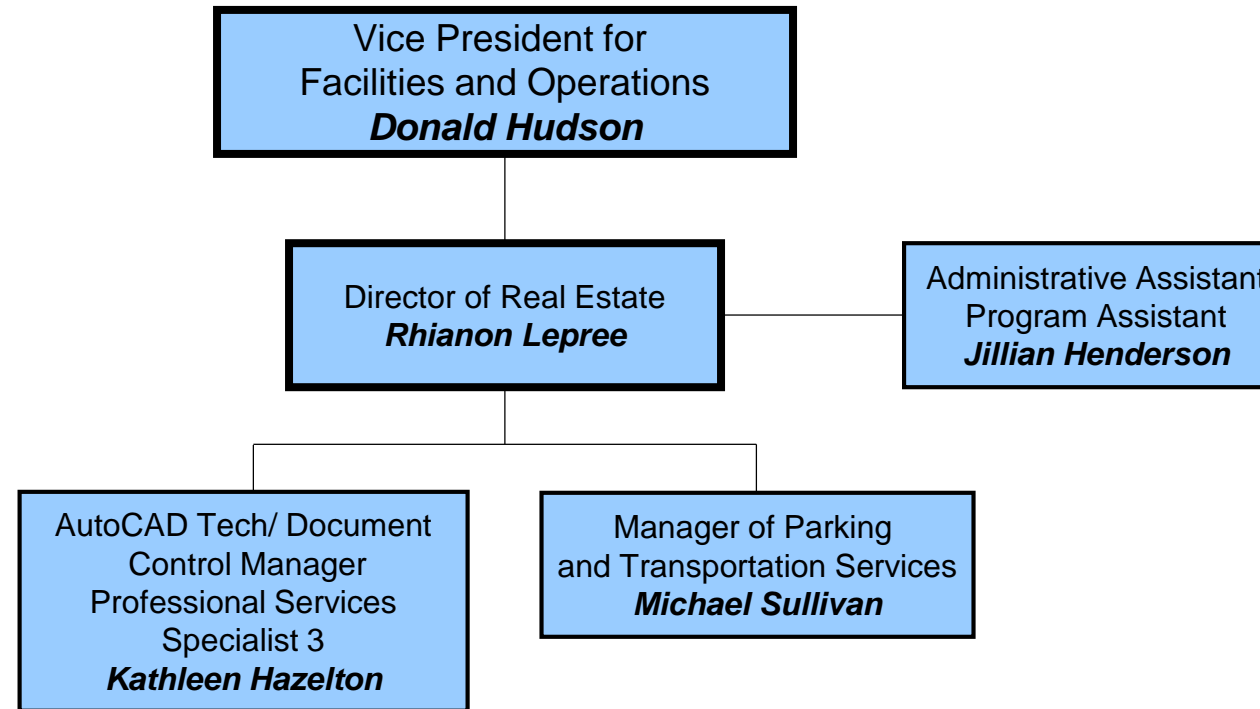



**OFFICE OF FACILITIES MANAGEMENT &
PLANT OPERATIONS
ORGANIZATION CHART**

Vice President for
Facilities and Operations
Donald Hudson

Special Projects Assistant
Professional Services Specialist 3
Darnley Biddle

Director of Facilities
Management & Plant Operations
John Fritsch

Administrative Assistant
Technical Assistant
Judy Ferriero

Associate Director of Facilities
Management & Plant Operations
Robert Haviland

Associate Director of Facilities
Management & Plant Operations
Katherine Hibbert

Click Here For
Organizational Details
of Service Shops

Click Here For
Organizational Details
of Trades Shops

Project Coordinator
Cynthia Gove

Financial Operations Manager
Assistant Supervisor 1
Russell Wilson

Work Control
Professional Services
Specialist 3
Julie Shockley

Administrative Assistant
Program Assistant
Nicole Ciccone

Program Assistant
Denise Barrie



**OFFICE OF FACILITIES MANAGEMENT &
PLANT OPERATIONS
TRADE SHOPS
ORGANIZATION CHART**

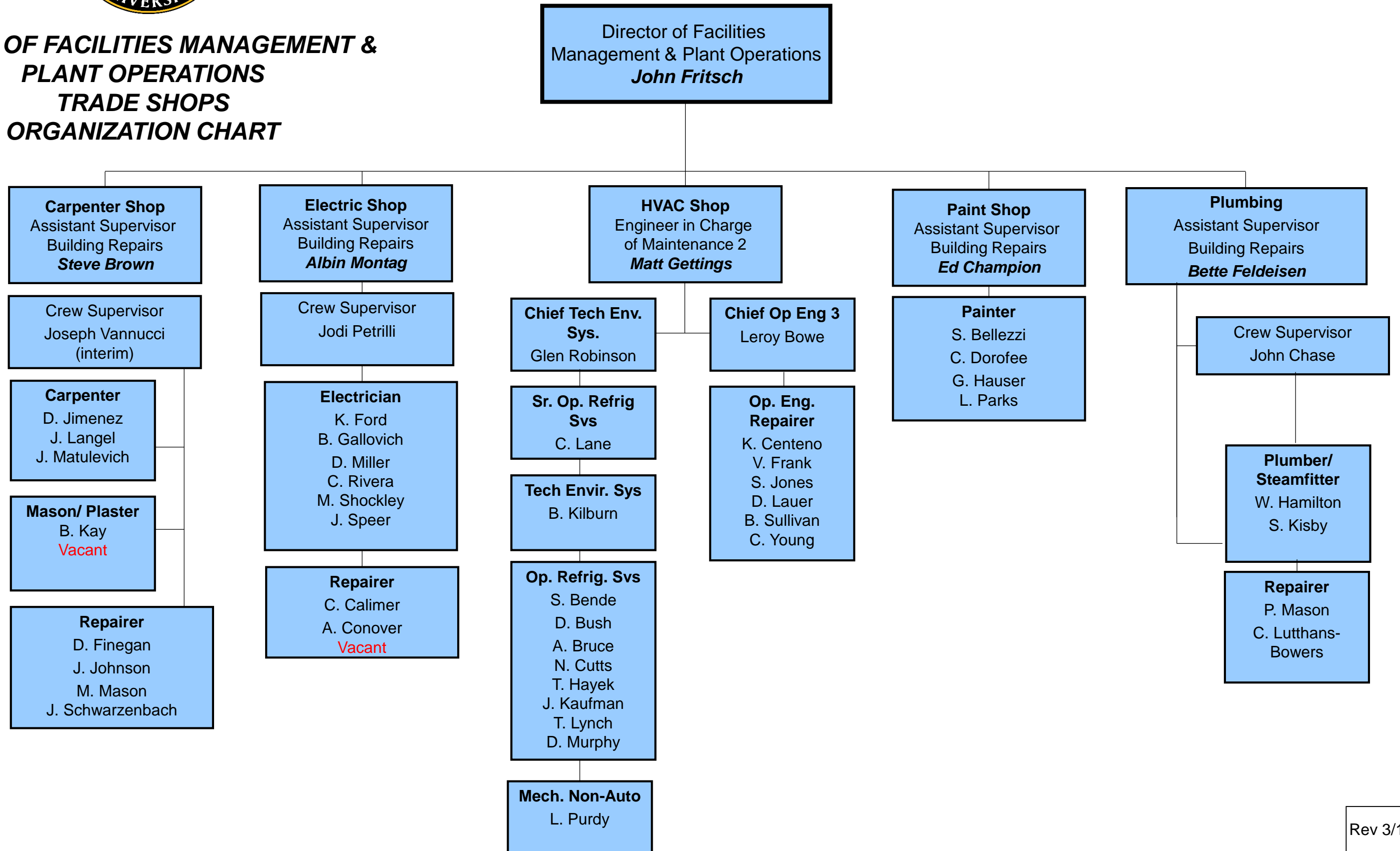



**OFFICE OF FACILITIES MANAGEMENT &
PLANT OPERATIONS
SERVICE SHOPS
ORGANIZATION CHART**

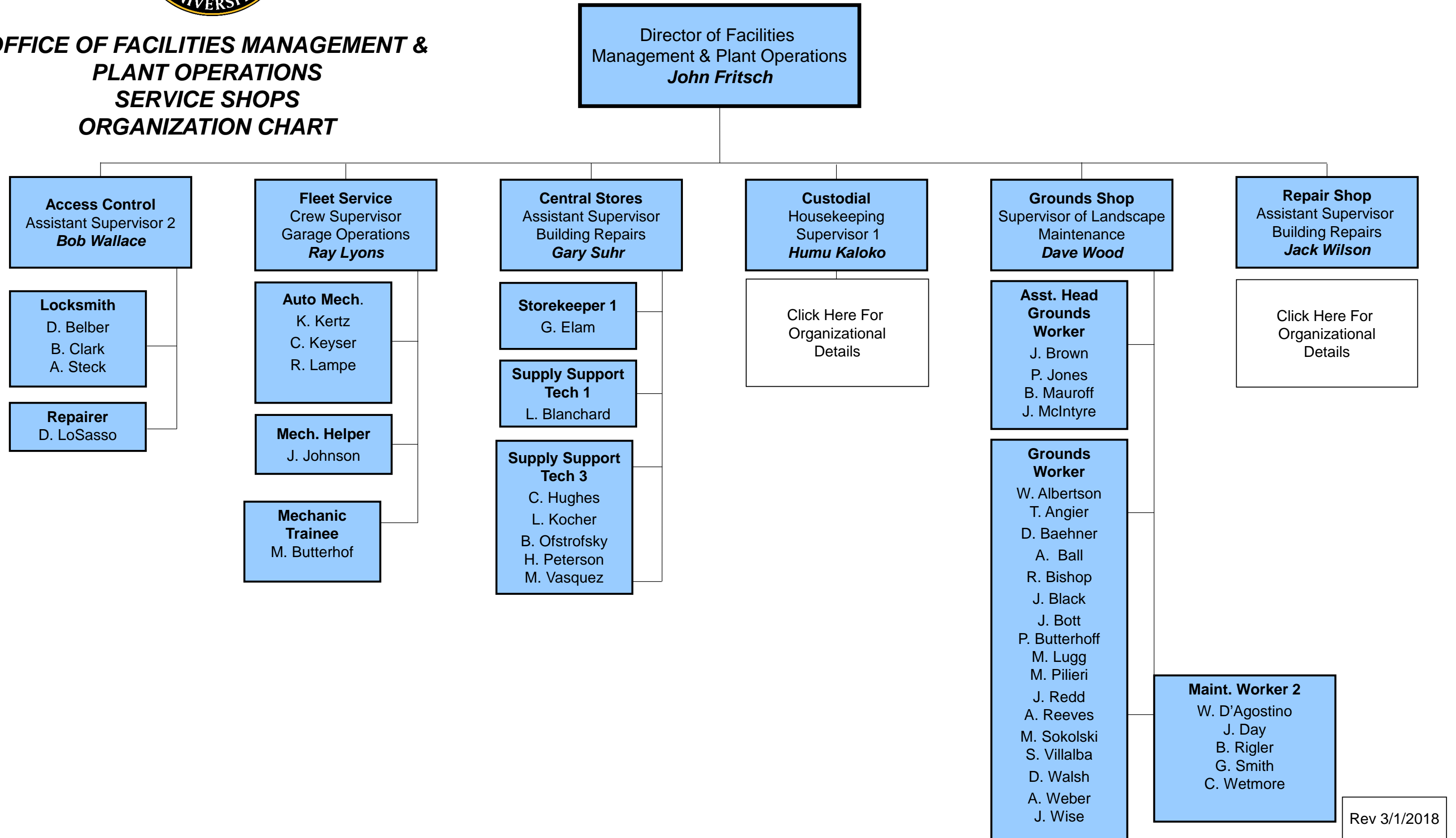



**OFFICE OF FACILITIES MANAGEMENT &
PLANT OPERATIONS
CUSTODIAL
ORGANIZATION CHART**

Director of Facilities
Management & Plant Operations
John Fritsch

Custodial
Housekeeping
Supervisor 1
Humu Kaloko

Day

Evening

Night

Assistant Supervisor 1
Night Shift
Daniel Snyder

Crew Supervisor
Dan Mendez

Crew Supervisor
Kevin Chandler

Crew Supervisor
Deborah Sallis

Crew Supervisor
Angel Rodriguez

Crew Supervisor
Ray Edwards

Crew Supervisor
(Interim)
Feron Flynn

Crew Supervisor
James Clark

Crew Supervisors
Vernon Beard

Crew Supervisor
James Daniel

Crew Supervisor
Jose Rodriguez

Crew Supervisor
Hector Torres

Sr. Bldg Maint. Workers
D. Avent
J. Burgess
A. Luong
F. Pham
U. Patel
R. Uriol

Sr. Bldg Maint. Workers
J. Cincotti
M. Henderson
D. Lopez
K. McKenzie
K. Miller
S. Owens

Sr. Bldg Maint. Workers
R. Bishop
K. Brown
L. Chaparro
P. Cherry
W. Crespo
R. Edwards
D. Kaye
S. Mendez
F. Narvaez
S. Torres
S. Tozer

Sr. Bldg Maint. Workers
D. Campbell
P. Howard
D. Harris
A. Jaremkow
J. Kelly
A. Marcos
T. Sessoms
J. Williams

Sr. Bldg Maint. Workers
J. Amaquandoh
M. Aquino
N. Barimah
A. Erazo
M. Longdon
D. May
R. Rodriguez
G. Smith

Sr. Bldg Maint. Workers
G. Rodriguez
R. Monagas
J. Soler

Sr. Bldg Maint. Workers
M. Adenai
R. Hudgson
M. Longdon
J. Swentkowski
S. Ward
M. Zane
M. Cahuana

Sr. Bldg Maint. Workers
C. Allen
C. Anderson
J. Baker
T. Boone
J. Cincotti
R. Cistrunk
D. Moody
A. Nieves
M. Palma

Sr. Bldg Maint. Workers
J. Amaquandoh
N. Barimah
A. Erazo
M. Longdon
D. May
R. Rodriguez
G. Smith
R. Skinner
B. Branch

Sr. Bldg Maint. Workers
Hi. Cruz
K. Curtis
S. Grandson
B. Hamlett
M. Hill
D. Smith
T. Pravinkumar

Sr. Bldg Maint. Workers
D. Anderson
S. Biddle
Y. Chacon-Fernandez
R. Dampf
P. Gonzalez
L. Kocher
K. Nguyen
H. Nguyen
O. Oyola
G. Valentine
H. Watson
R. Ruiz



**OFFICE OF FACILITIES MANAGEMENT &
PLANT OPERATIONS
REPAIR SHOP
ORGANIZATION CHART**

